

Sì

collection

biel
DIVANI ITALIANI
dal 1978



Sì

collection

Design: Liviano Battistoni



Sì

all'eleganza

Sì

alla comodità

Sì

al trend



Sì
collection

“Un design
che non teme
le mode
ma le interpreta,,

*“A design
that does not fear
the fashions
but he interprets them”*

ILONA 06

GESSY 16

ISMA 28

LIA 38

48 ZENO

58 KENT

72 LINUS

82 MARK

ILONA

Sì

collection

DESIGN ITALIANO, COMFORT TOTALE

Nati da un'idea intelligente e sorprendente, i divani della SI collection presentano otto tipologie di comode sedute alle quali sono abbinabili quattro differenti braccioli che danno vita ad innumerevoli soluzioni valide sotto il punto di vista estetico e del comfort. Nelle immagini del catalogo sono presentate tutte le combinazioni possibili, nei vari modelli, fra struttura e braccioli. Nelle pagine seguenti ILONA vi sorprenderà.



ITALIAN DESIGN, TOTAL COMFORT

Born from an intelligent and surprising idea, the sofas of the SI collection present eight types of comfortable seating to which four different armrests can be combined give life to innumerable valid solutions from an aesthetic and comfort point of view. In the images of the catalog all possible combinations are presented, in the various models, between the structure and the armrests. ILONA will surprise you on the following pages.

ILONA



GESSY



ISMA



LIA



ZENO



KENT



LINUS



MARK





ELEMENTO 180 + 2 braccioli OVAL - cm. 222

DESIGN ITALIANO, COMFORT TOTALE

ILONA è improntato ad uno spirito decisamente conviviale, dal design sobrio e contemporaneo, con cui è possibile realizzare ambienti confortevoli nei quali godere del proprio tempo libero in una condizione di meritato relax.

ILONA unisce brillantemente forme, materiali e cromatismi, contestualizzandoli in spazi informali, che trasmettono energia ed invitano alla socialità.

A questa personalità forte e decisa si uniscono elementi di design che lo rendono unico, aiutandolo ad inserirsi in ambienti di gusto diverso.

ILONA
Design: Liviano Battistoni



ELEMENTO 180 + 2 braccioli SOFT - cm. 214

ITALIAN DESIGN, TOTAL COMFORT

ILONA is characterized by a strongly convivial spirit and by a sober and modern design, and it's perfect for comfortable locations where to enjoy your free time in a condition of deserved relax. ILONA brilliantly combines shapes, materials and chromatisms, inserting them in informal spaces, which instill energy and invite you to the sociality. Its strong and definite personality is associated with design elements which make it unique and give it the possibility to be placed in several different locations.



ELEMENTO 200 + 2 braccioli PETIT - cm. 222



ELEMENTO 180 + 2 braccioti PIRAMID - cm. 206



ELEMENTO 60 + 2 braccioti PIRAMID - cm. 86



ELEMENTO 180 + penisola 90 + 2 braccioli SOFT - cm. 304x165

UN DIVANO UNICO E SORPRENDENTE

Nati da un'idea intelligente e sorprendente, i divani della SI collection presentano otto tipologie di comode sedute alle quali sono abbinabili quattro differenti braccioli che danno vita ad innumerevoli soluzioni valide sotto il punto di vista estetico e del comfort. Nelle immagini del catalogo sono presentate tutte le combinazioni possibili, nei vari modelli, fra struttura e braccioli. Nelle pagine seguenti GESSY vi sorprenderà.



A UNIQUE AND SURPRISING DESIGN

Born from an intelligent and surprising idea, the sofas of the SI collection present eight types of comfortable seating to which four different armrests can be combined give life to innumerable valid solutions from an aesthetic and comfort point of view. In the images of the catalog all possible combinations are presented, in the various models, between the structure and the armrests. GESSY will surprise you on the following pages.

ILONA



GESSY

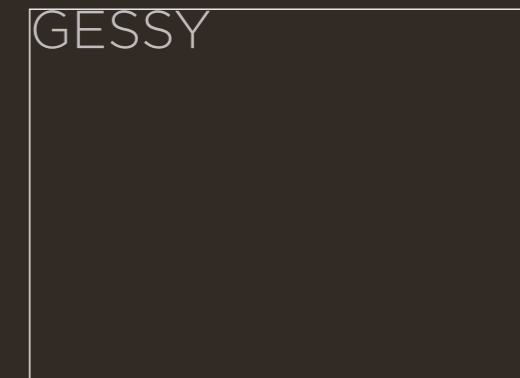

ISMA



LIA



ZENO



KENT



LINUS



MARK



GESSY

Design: Liviano Battistoni

UN DIVANO UNICO E SORPRENDENTE

*Innovazione, versatilità, funzioni,
Design Italiano. Perché il divano non è solo
una seduta, ma un luogo sul quale vivere
e trascorrere molte ore della tua giornata.
GESSY accompagna la tua vita e il tuo modo
di essere, in ogni dettaglio, in ogni
momento, in ogni sfumatura di comfort.
Un divano che ti sorprende da ogni punto
di vista: nel design, nelle funzioni, nei materiali,
nei colori. GESSY si fa subito notare
per il design accattivante che offre
nel tuo living il comfort più seducente.*

A UNIQUE AND SURPRISING DESIGN

Innovation, versatility, functions and Italian design.
The sofa isn't only a seat, but a place where to live
and spend many hours of your day.
GESSY accompanies your life and your lifestyle,
in every detail and in every moment of comfort.
A sofa that surprises you from every point of view:
in its design, functions, materials and colours.
You can immediately notice GESSY for its beautiful
design, which offers you the most pleasant comfort
in your living space.



ELEMENTO 60 + 2 braccioli OVAL - cm. 102



ELEMENTO 100 + 2 braccioli PETIT - cm. 222



ELEMENTO 180 + pentsola 90 + 2 braccioli PETIT - cm. 292X165



ELEMENTO 180 + 2 braccioli OVAL - cm. 222



ELEMENTO 180 + 2 braccioli SOFT - cm. 214

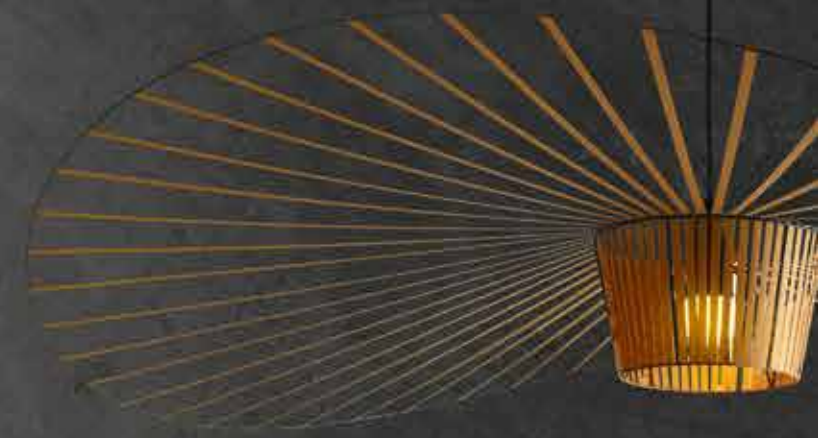



ELEMENTO 180 + 2 braccioli PIRAMID - cm. 206

ISMA

Sì

collection

LASCIATI ANDARE AL RELAX

Nati da un'idea intelligente e sorprendente, i divani della SI collection presentano otto tipologie di comode sedute alle quali sono abbinabili quattro differenti braccioli che danno vita ad innumerevoli soluzioni valide sotto il punto di vista estetico e del comfort. Nelle immagini del catalogo sono presentate tutte le combinazioni possibili, nei vari modelli, fra struttura e braccioli. Nelle pagine seguenti ISMA vi sorprenderà.



ENJOY YOUR RELAX

Born from an intelligent and surprising idea, the sofas of the SI collection present eight types of comfortable seating to which four different armrests can be combined give life to innumerable valid solutions from an aesthetic and comfort point of view. In the images of the catalog all possible combinations are presented, in the various models, between the structure and the armrests. ISMA will surprise you on the following pages.

ILONA



GESSY



ISMA

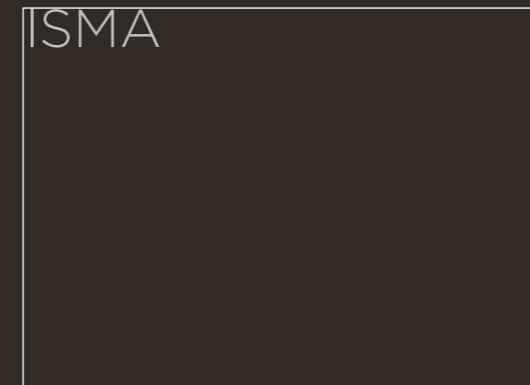

LIA



ZENO



KENT



LINUS



MARK



LASCIATI ANDARE AL RELAX



Alta manifattura "sartoriale", eleganza e comodità sono gli aggettivi che maggiormente rappresentano ISMA, proposto per coloro che hanno gusti raffinati e amano far vivere il proprio divano nella quotidianità della loro casa, protagonista indiscusso di un living elegante. Equilibrato, perfetto tra forma ed ergonomia di seduta. Le sedute profonde invitano a lasciarsi andare al relax. La morbidezza dei tessuti e la qualità dell'imbottitura fanno di ISMA la massima espressione in fatto di comodità, ed il design unisce ergonomia e funzionalità per un risultato pregiato

ENJOY YOUR RELAX

High "sartorial" manufacture, elegance and comfort are the features that mostly represent ISMA, which is proposed for those who have refined tastes and love to emphasize their own sofa in their daily life of their home. The large and deep seats invite you to relax. The softness of the fabrics and the quality of the stuffing make ISMA the maximum expression of comfort, and its design combines ergonomics and functionality, and the result is precious.







ELEMENTO 180 + 2 braccioli SOFT - cm. 214



ELEMENTO 180 + terminale 92 + 1 bracciolo OVAL - cm. 293x220

UNA MORBIDEZZA CHE TI ACCOGLIE

Nati da un'idea intelligente e sorprendente, i divani della SI collection presentano otto tipologie di comode sedute alle quali sono abbinabili quattro differenti braccioli che danno vita ad innumerevoli soluzioni valide sotto il punto di vista estetico e del comfort. Nelle immagini del catalogo sono presentate tutte le combinazioni possibili, nei vari modelli, fra struttura e braccioli. Nelle pagine seguenti LIA vi sorprenderà.



A SOFTNESS THAT GIVES YOU COMFORT

Born from an intelligent and surprising idea, the sofas of the SI collection present eight types of comfortable seating to which four different armrests can be combined give life to innumerable valid solutions from an aesthetic and comfort point of view. In the images of the catalog all possible combinations are presented, in the various models, between the structure and the armrests. LIA will surprise you on the following pages.

ILONA



GESSY



ISMA



LIA

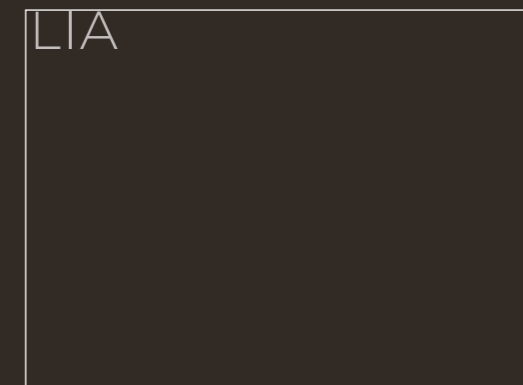

ZENO



KENT



LINUS



MARK



LIA

Design: Liviano Battistoni

UNA MORBIDEZZA CHE TI ACCOGLIE

LIA accompagna molte delle tue serate, deve parlarti di te e deve saperti accogliere, accompagnandoti a lungo nei tuoi piacevoli momenti di relax.

E' su questo che LIA è in grado di fare la differenza, assicurandoti qualità duratura senza rinunciare all'estetica, allo stile e al comfort.

LIA si propone come modello di piacevole e innovativo design, con la caratteristica di linee essenziali e pulite per donare al tuo relax un grande e sicuro comfort.



ELEMENTO 180 + 2 braccioti SOFT - cm. 214



ELEMENTO 60 + 2 braccioti PETIT - cm. 82



A SOFTNESS THAT GIVES YOU COMFORT

With LIA you can spend many of your hours, it has to accompany you in your pleasant moments of relax. This makes the difference in LIA sofa, assuring you long-lasting quality without losing aesthetics, style and comfort.

LIA stands out for being a model of pleasant and innovative design, with essential and clean lines, to give your relax a great and certain comfort.



ELEMENTO 200 + pentsola 90 + 2 braccioti PETIT - cm. 314X165

*E' il dettaglio che fa la differenza.
I piedini slanciati ed il design stile essenziale conferiscono a LIA un'aria piena di freschezza. Stile e praticità. Gli amanti degli ambienti funzionali e moderni apprezzeranno sicuramente il divano LIA, con le sue tonalità fresche e giovani che doneranno una nota frizzante agli interni.*

*Details make the difference.
Its slender legs and its essential design give LIA a look full of freshness. Style and practicality. The lovers of functional and modern locations will surely appreciate LIA sofa, with its fresh and young tonalities which will give a lively mark to any inner location.*



ELEMENTO 180 + 2 braccioli OVAL - cm. 222



ELEMENTO 160 + 2 braccioli PIRAMID - cm. 186



ZENO

Sì
collection

UN LINGUAGGIO ESTETICO RAFFINATO

*Nati da un'idea intelligente e sorprendente, i divani della SI collection presentano otto tipologie di comode sedute alle quali sono abbinabili quattro differenti braccioli che danno vita ad innumerevoli soluzioni valide sotto il punto di vista estetico e del comfort. Nelle immagini del catalogo sono presentate tutte le combinazioni possibili, nei vari modelli, fra struttura e braccioli. Nelle **pagine seguenti ZENO vi sorprenderà.***



AN AESTHETIC AND REFINED DESIGN

Born from an intelligent and surprising idea, the sofas of the SI collection present eight types of comfortable seating to which four different armrests can be combined give life to innumerable valid solutions from an aesthetic and comfort point of view. In the images of the catalog all possible combinations are presented, in the various models, between the structure and the armrests. ZENO will surprise you on the following *pages*.

ILONA



GESSY



ISMA



LIA



ZENO



KENT



LINUS



MARK



UN LINGUAGGIO ESTETICO RAFFINATO

A ciascuno di noi corrisponde una diversa idea di casa, modi di abitare ma per tutti la casa è il luogo dell'accoglienza e degli affetti, di una storia personale e della nostra evoluzione nel tempo. ZENO è un' affascinante modello scolpito da linee impeccabili e da un perfetto equilibrio tra tradizione costruttiva e modernità di design.

ZENO è una proposta concreta che dà energia e corpo a modi di vivere ed abitare la casa di oggi, un linguaggio estetico raffinato che si esprime nella scelta dei materiali di pregio e accostamenti studiati per ottenere un design senza tempo.

ZENO
Design: Liviano Battistoni



ELEMENTO 180 + 2 braccioli PIRAMID - cm. 206



ELEMENTO 60 + 2 braccioli PETIT - cm. 82

AN AESTHETIC AND REFINED DESIGN

Everyone has a different idea of home and different ways of living, but for everyone, the home is the place of the hospitality and for the loved ones. It represents our personal story and our evolution in time. ZENO is a fashionable model, characterized by elegant lines and by a perfect balance between manufacturing tradition and modernity of design.

This model is a concrete proposal which gives energy to the ways of living today's house, an aesthetic and refined language which expresses itself in the precious materials and combinations, which are studied to obtain a timeless design.



ELEMENTO 180 + angolo 94 + ELEMENTO 140 + 2 braccioti SOFT - cm. 291X251



ELEMENTO 160 + 2 braccioli PETIT - cm. 182



ELEMENTO 200 + 2 braccioli OVAL - cm. 242

KENT

Sì
collection

UN SUGGESTIVO LIFESTYLE

*Nati da un'idea intelligente e sorprendente, i divani della SI collection presentano otto tipologie di comode sedute alle quali sono abbinabili quattro differenti braccioli che danno vita ad innumerevoli soluzioni valide sotto il punto di vista estetico e del comfort. Nelle immagini del catalogo sono presentate tutte le combinazioni possibili, nei vari modelli, fra struttura e braccioli. Nelle **pagine seguenti KENT vi sorprenderà.***



A SUGGESTIVE LIFESTYLE

Born from an intelligent and surprising idea, the sofas of the SI collection present eight types of comfortable seating to which four different armrests can be combined give life to innumerable valid solutions from an aesthetic and comfort point of view. In the images of the catalog all possible combinations are presented, in the various models, between the structure and the armrests. KENT will surprise you on the following pages.

ILONA



GESSY



ISMA



LIA



ZENO



KENT

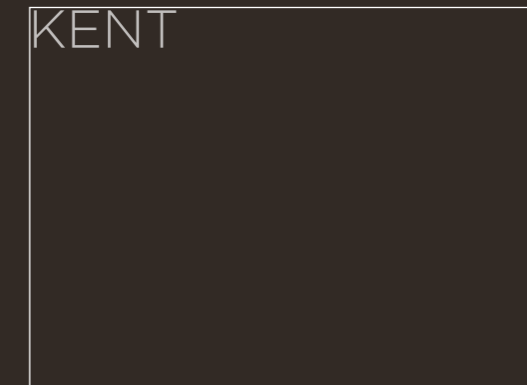

LINUS



MARK



KENT
Design: Liviano Battistoni

A SUGGESTIVE LIFESTYLE

The inner environments, which are protagonists of your daily life, merit to be enriched by furniture that can give you more and more pleasant and relaxing time, that we dedicate to our home and ourselves. The sofa represents our lifestyle and becomes an absolute protagonist, both when we seat on it for relaxing, and when we share it in company with our friends. KENT can express and instill emotions and sensations. Every detail is very accurate and it's made with expert care. The result is a suggestive lifestyle, characterized by living and convivial atmospheres.

UN SUGGESTIVO LIFESTYLE

Gli ambienti interni, protagonisti della nostra vita quotidiana meritano di venire arricchiti da arredi che sanno rendere ancor più piacevole e rilassante il tempo che dedichiamo alla casa e a noi. Il divano rispecchia il nostro modo di vivere, diventa protagonista assoluto sia quando ci accoglie per rilassarci sia quando lo condividi con gli amici in compagnia. KENT ha l'attitudine di interpretare e trasmettere emozioni e sensazioni. Ogni dettaglio esprime una sua ragione ed è eseguito con sapiente cura. Il risultato è un suggestivo lifestyle dalle atmosfere abitative conviviali.





ELEMENTO 180 + 1 bracciolo PIRAMID + terminale - cm. 283x220



ELEMENTO 180 + 2 braccioli SOFT - cm. 214



Reversibile - ELEMENTO 240 + 2 braccioli SOFT - cm. 274X165



ELEMENTO 180 + 2 braccioli PETIT - cm. 202

Kent, grazie alle sue dimensioni generose, diventerà sicuramente il pezzo forte di ogni living contemporaneo. La dinamicità delle forme dona a questo modello un aspetto moderno ed una grande capacità arredativa.

Kent, thanks to its generous sizes, will surely become the showpiece of every modern living space. The dynamism of the shapes gives a modern look and a great furnishing capability to this model.



ELEMENTO 160 + 2 braccioli PIRAMID - cm. 186



ELEMENTO 200 + angolo 94 + ELEMENTO 160 - 2 braccioli PETIT - cm. 305X265

LINUS

Sì

collection

UN DESIGN INCONFONDIBILE

Nati da un'idea intelligente e sorprendente, i divani della SI collection presentano otto tipologie di comode sedute alle quali sono abbinabili quattro differenti braccioli che danno vita ad innumerevoli soluzioni valide sotto il punto di vista estetico e del comfort. Nelle immagini del catalogo sono presentate tutte le combinazioni possibili, nei vari modelli, fra struttura e braccioli. Nelle pagine seguenti LINUS vi sorprenderà.



A UNIQUE DESIGN

Born from an intelligent and surprising idea, the sofas of the SI collection present eight types of comfortable seating to which four different armrests can be combined give life to innumerable valid solutions from an aesthetic and comfort point of view. In the images of the catalog all possible combinations are presented, in the various models, between the structure and the armrests. LINUS will surprise you on the following pages.

ILONA



GESSY



ISMA



LIA



ZENO



KENT



LINUS

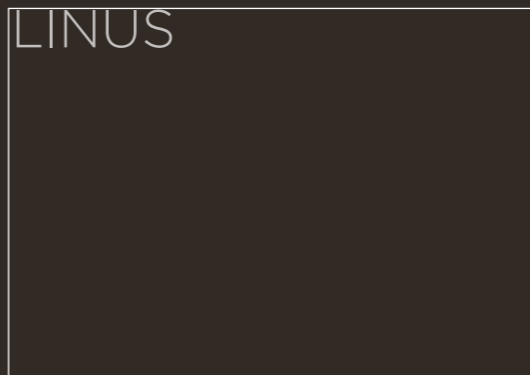

MARK



LINUS
Design: Liviano Battistoni

UN DESIGN INCONFONDIBILE

L'eleganza e la raffinatezza del made in Italy rappresentate nel divano LINUS sono evidenti dal primo sguardo. LINUS si esprime evidenziando la qualità nella realizzazione, ricerca dei dettagli, innovazione nelle proposte anche per soluzioni abitative di grande prestigio e design italiano con forme uniche di stile; un divano dal design inconfondibile che unisce il comfort di un salotto all'eleganza estetica, creando giochi di forme e materiali.



ELEMENTO 160 + 2 braccioli OVAL - cm. 202

A UNIQUE DESIGN

The elegance and refinement of the "Made in Italy" mark are represented in LINUS sofa, and they are immediately clear. LINUS is characterized by a great quality in the manufacturing and by a deep research of the details, and it's innovative in the proposals also for living solutions with great Italian prestige and design, with unique style shapes. A unique design that mixes the comfort of a sitting-room to the aesthetic elegance, creating cool effects of shapes and materials.



ELEMENTO 60 + 2 braccioli PETIT - cm. 82



ELEMENTO 180 + 2 braccioli PIRAMID - cm. 206



ELEMENTO 180 + 2 braccioli PETIT - cm. 202



ELEMENTO 180 + penisola 90 + 2 braccioti OVAL - cm. 312x165



ELEMENTO 160 + 2 braccioli SOFT - cm. 194

UN ABBRACCIO DI MORBIDEZZA

Nati da un'idea intelligente e sorprendente, i divani della SI collection presentano otto tipologie di comode sedute alle quali sono abbinabili quattro differenti braccioli che danno vita ad innumerevoli soluzioni valide sotto il punto di vista estetico e del comfort. Nelle immagini del catalogo sono presentate tutte le combinazioni possibili, nei vari modelli, fra struttura e braccioli. Nelle pagine seguenti MARK vi sorprenderà.



AN EMBRACE OF SOFTNESS

Born from an intelligent and surprising idea, the sofas of the SI collection present eight types of comfortable seating to which four different armrests can be combined give life to innumerable valid solutions from an aesthetic and comfort point of view. In the images of the catalog all possible combinations are presented, in the various models, between the structure and the armrests. MARK will surprise you on the following pages.

ILONA



GESSY



ISMA



LIA



ZENO



KENT



LINUS



MARK





ELEMENTO 180 + 2 braccioli SOFT - cm. 214

UN ABBRACCIO DI MORBIDEZZA

MARK, un divano importante dalle forme morbide dei cuscini dello schienale che riempiono abbondantemente la struttura per offrire rilassanti sensazioni. Comode sedute che regalano la situazione ideale per perdersi in un abbraccio di morbidezza.

Un modello senza tempo di facile ambientazione in contesti che spaziano fra un gusto tradizionale e moderno.

Un insieme di forme armoniose, dal design di forte personalità esaltano l'esclusività del modello.

Con MARK o il living acquista il "sapore" di un'eleganza senza tempo, ti cattura e ti invita a sederti e rilassarti.

MARK
Design: Liviano Battistoni



ELEMENTO 120 + 2 braccioli PIRAMID - cm. 146

AN EMBRACE OF SOFTNESS

MARK is an important sofa, characterized by the soft shapes of the back cushions that fill the structure in an abundant way to offer relaxing sensations. Comfortable seats that gift you with the ideal situation for a soft embrace. A timeless model, easy to be settled in both traditional and modern environments. A union of harmonious shapes, characterized by a design with a strong personality, enhance the exclusiveness of the model.

With MARK, the living space acquires the "taste" of a timeless elegance, and it captures and invites you to seat and relax.



ELEMENTO 180 + 2 braccioli PETIT - cm. 202

ELEMENTO 160 + 2 braccioli PETIT - cm. 182

Mark riunirà tutti in salotto grazie alla sua seduta generosa. Moderno con le sue forme morbide troverà perfettamente la sua ideale collocazione in un ambiente contemporaneo senza tempo. Con la sua stoffa pregiata e il look moderno Mark donerà carattere al tuo living e creerà un'atmosfera calda, rilassante ed accogliente.

Mark will gather everyone in the sitting room thanks to its generous seat. It is modern and has soft shapes, which make it perfect to be placed in a modern and timeless location. With its precious cloth and modern look, Mark will give personality to your living space and will create a warm, relaxing and embracing atmosphere.





ELEMENTO 200 + 2 braccioli OVAL - cm. 240



ELEMENTO 180 + pentsola 90 + 2 braccioni SOFT - cm. 304x165

Caratteristiche tecniche per i modelli:
ILONA/ISMA/GESSY/LIA/ZENO/LINUS/KENT/MARK

Rivestimento: completamente sfoderabile

Struttura: in legno stagionato, multistrato e agglomerato

Molleggio Seduta: cinghia elastica mm. 80 tesa meccanicamente

Imbottitura struttura e braccioli: tamponi in poliuretano espanso indeformabile D 30/40 kg/m³ completamente rivestiti in ovatta di poliestere

Schienale sagomato: in poliuretano espanso indeformabile D 18/21 kg/m³ ricoperto in ovatta di poliestere

Seduta: in poliuretano espanso indeformabile D 30 kg/m³ ricoperto in ovatta di poliestere

Piedi sui modelli GESSY-LIA-KENT-MARK - a scelta in legno naturale, metallo e metallo colore antracite.

Technical characteristics for model:
ILONA/ISMA/GESSY/LIA/ZENO/LINUS/KENT/MARK

Covering: Completely removable

Frame: in seasoned, multilayered wood and particle board

Seat springing: 80 mm mechanically tightened elastic webbing

Frame and armrest upholstery: fillers in non-deformable polyurethane foam D 30/40 kg/m³ completely covered in polyester padding

Shaped back: non-deformable polyurethane foam D 18/21 kg/m³ covered in polyester padding

Seat: non-deformable polyurethane foam D 30 kg/m³ covered in polyester padding

Feet on models GESSY-LIA-KENT-MARK - choice of wood col. natural, metal, anthracite color metal.

TIPOLOGIE BRACCIOLI

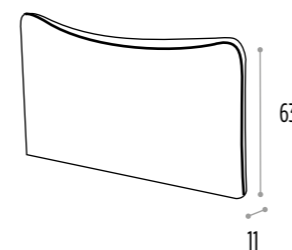

BRACCILO PETIT



BRACCILO PIRAMID

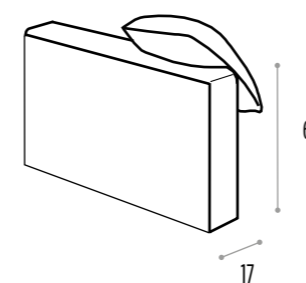
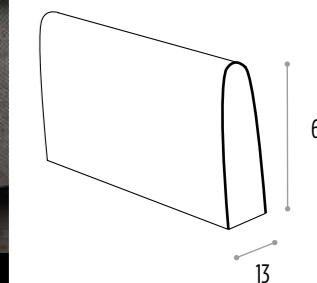

BRACCILO SOFT



BRACCILO OVAL

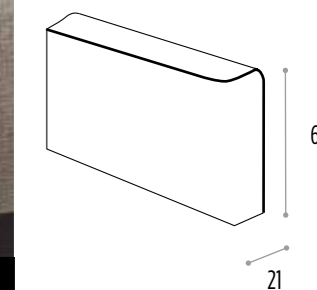

TIPOLOGIE PIEDINI



Legno



Metallo



Metallo colore antracite

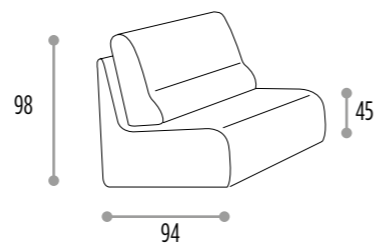

ELEMENTI

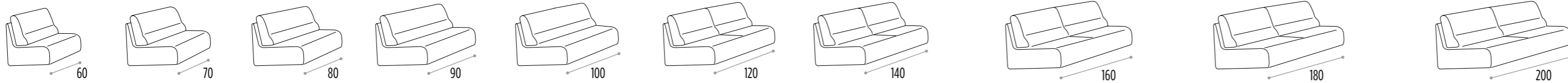

PENISOLA

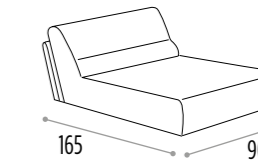

BRACCIOLO PETIT

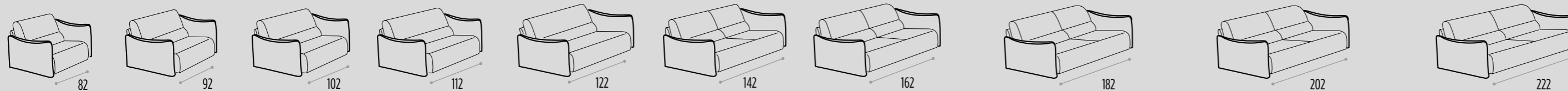

PENISOLA

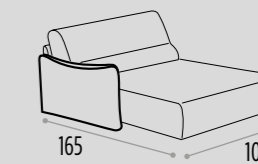

BRACCIOLO PIRAMID

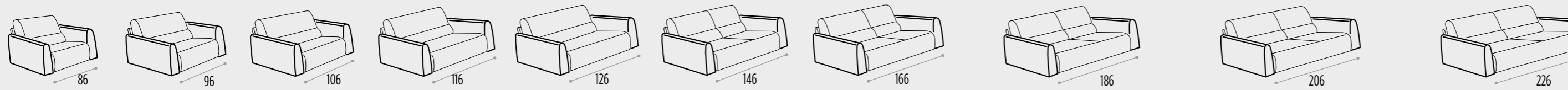

PENISOLA

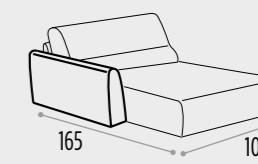

BRACCIOLO OVAL

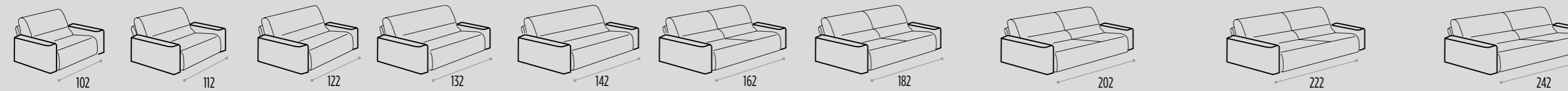

PENISOLA

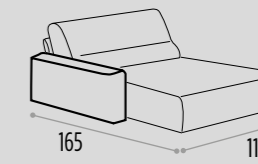

BRACCIOLO SOFT

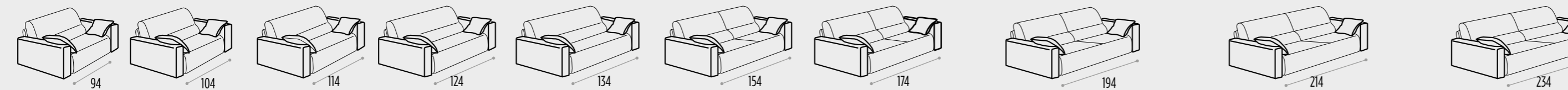

PENISOLA

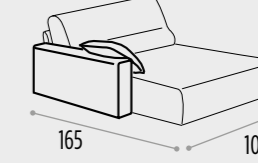

ELEMENTI

TERMINALE CORTO

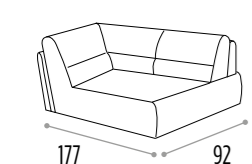

TERMINALE

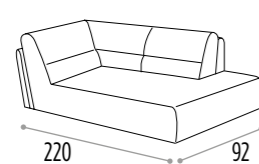

ANGOLO

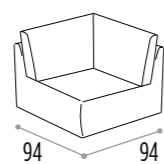

POUFF ILONA QUADRATO

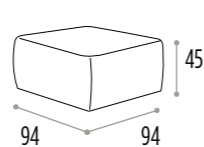

POUFF SI COLLECTION

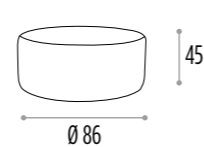

CUSCINO DECOR 06

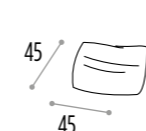

CUSCINO DECOR 08

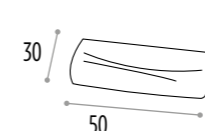

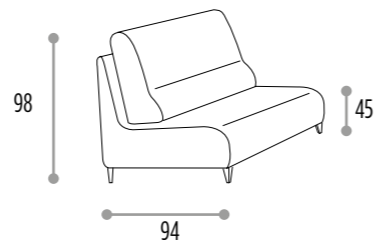

ELEMENTI

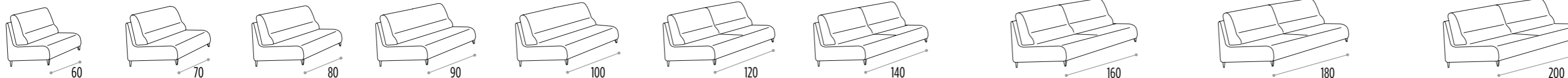

PENISOLA

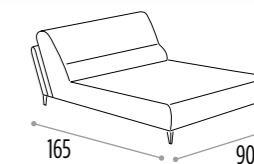

BRACCIOLO PETIT

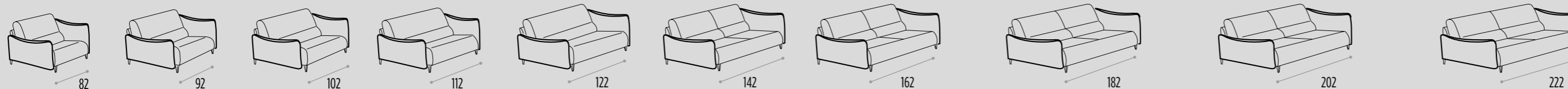

PENISOLA

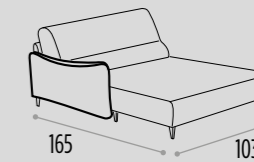

BRACCIOLO PIRAMID

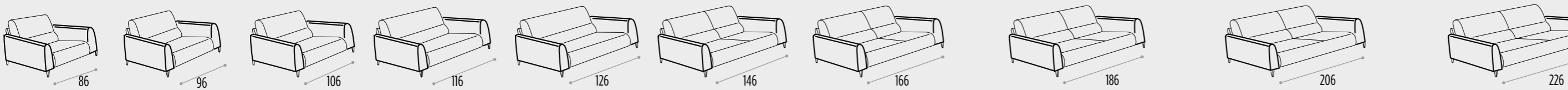

PENISOLA

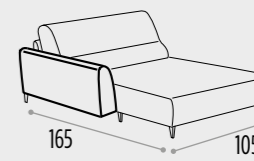

BRACCIOLO OVAL

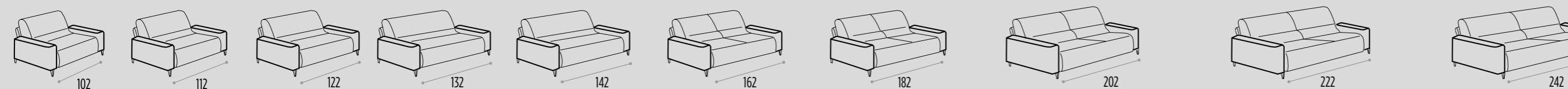

PENISOLA

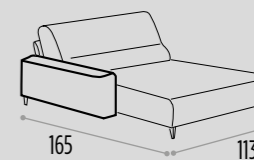

BRACCIOLO SOFT

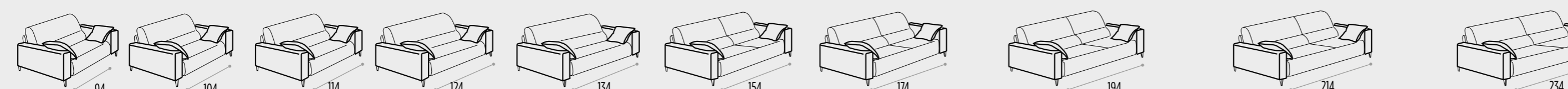

PENISOLA

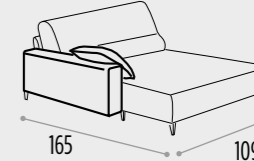

ELEMENTI

TERMINALE CORTO

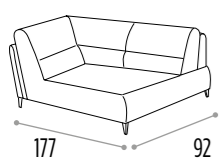

TERMINALE



ANGOLO

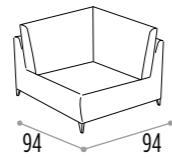

POUFF GESSY QUADRATO

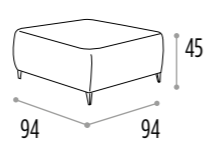

POUFF SI COLLECTION

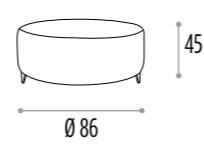

CUSCINO DECOR 06

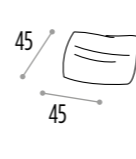

CUSCINO DECOR 08

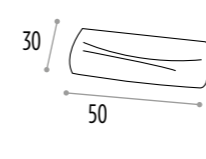

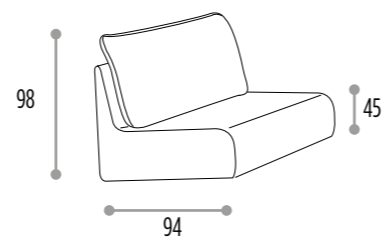

ELEMENTI

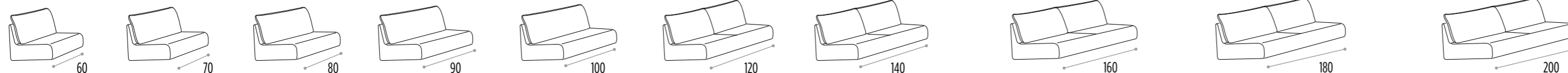

PENISOLA

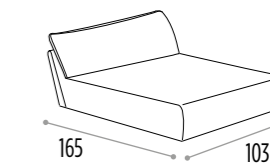

BRACCIOLO PETIT

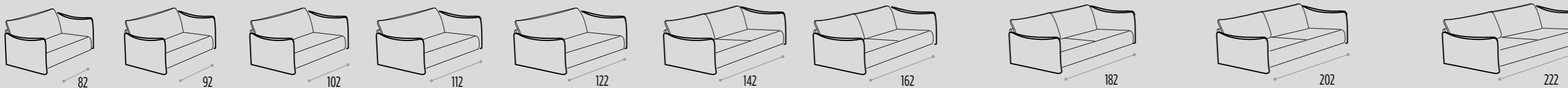

PENISOLA

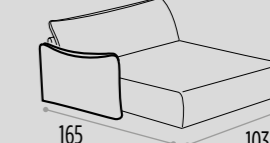

BRACCIOLO PIRAMID

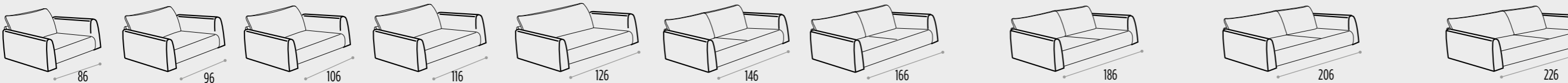

PENISOLA

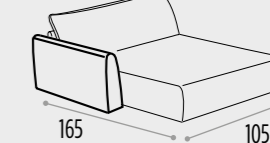

BRACCIOLO OVAL

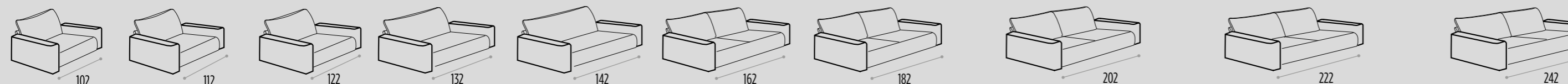

PENISOLA

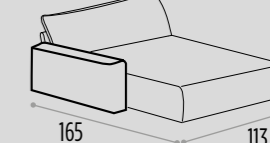

BRACCIOLO SOFT

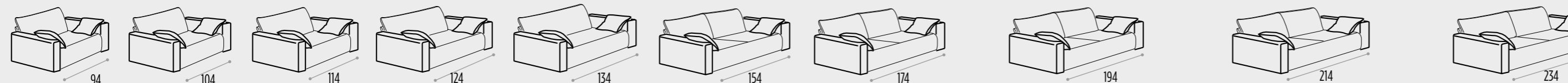

PENISOLA



ELEMENTI

TERMINALE CORTO

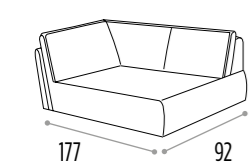

TERMINALE

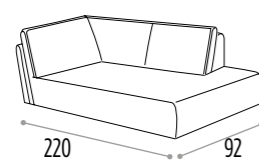

ANGOLO

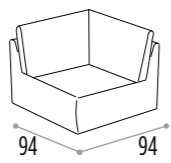

POUFF ISMA QUADRATO

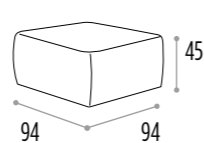

POUFF SI COLLECTION

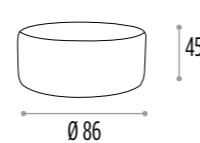

CUSCINO DECOR 06

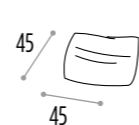

CUSCINO DECOR 08

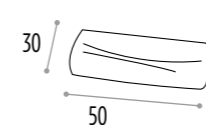

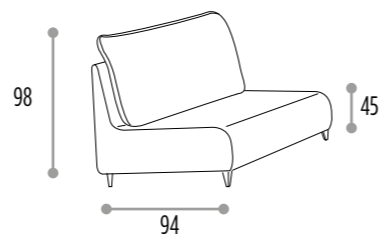

ELEMENTI

PENISOLA

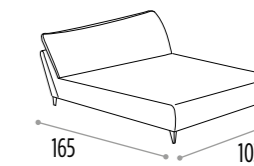
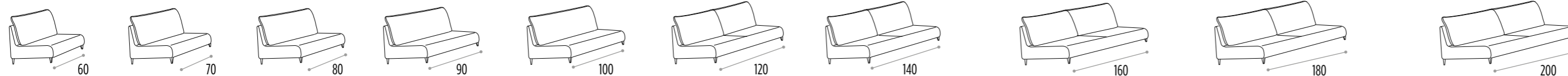

BRACCIOLO PETIT

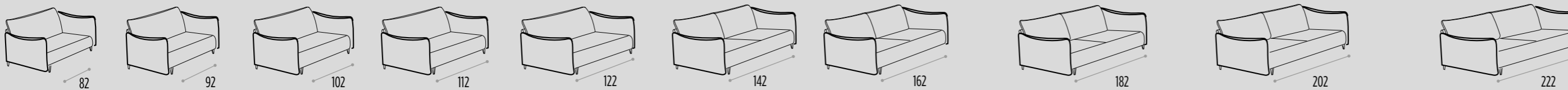

PENISOLA

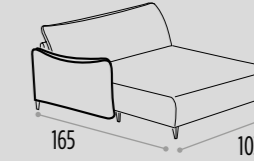
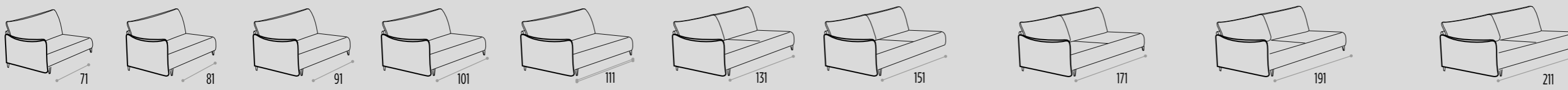

BRACCIOLO PIRAMID

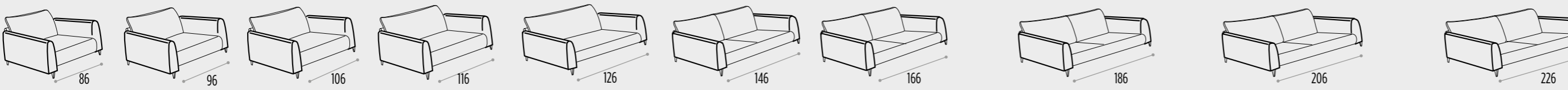

PENISOLA

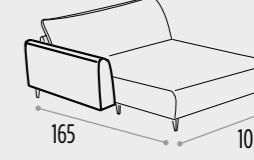
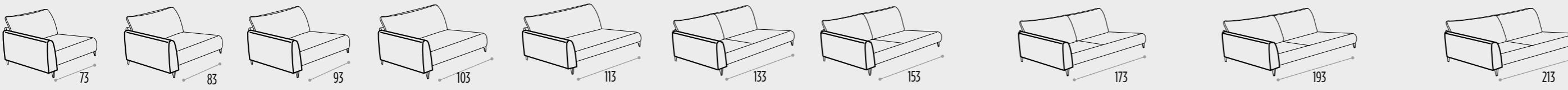

BRACCIOLO OVAL

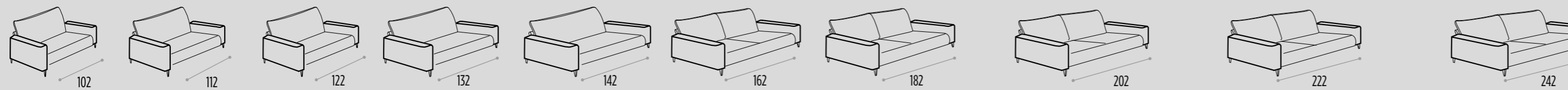

PENISOLA

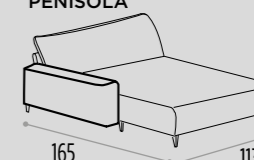
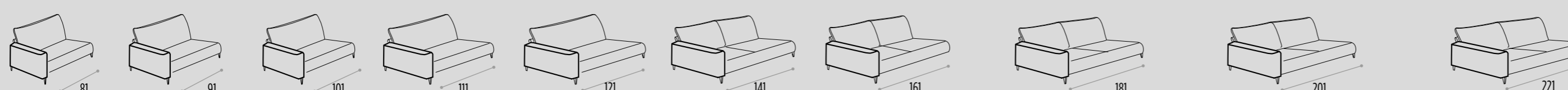

BRACCIOLO SOFT

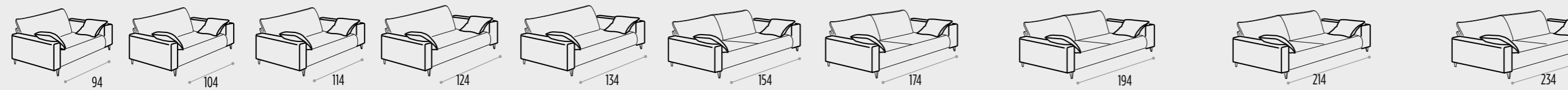

PENISOLA

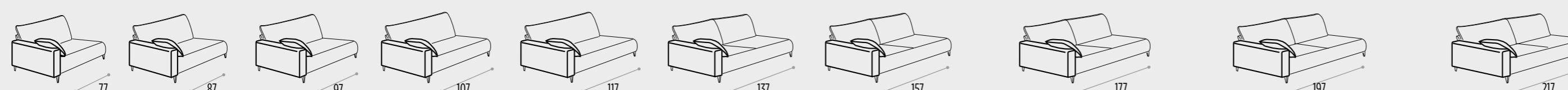

ELEMENTI

TERMINALE CORTO

TERMINALE

ANGOLO

POUFF LIA QUADRATO

POUFF SI COLLECTION

CUSCINO DECOR 06

CUSCINO DECOR 08

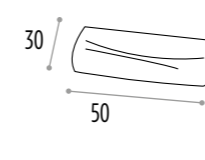
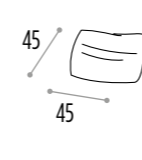
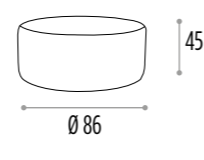
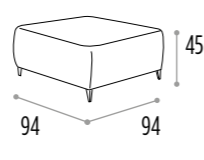
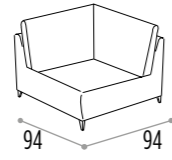
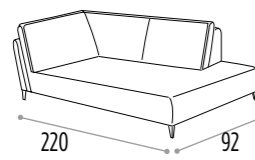
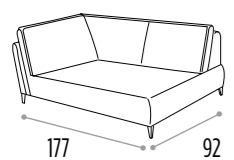

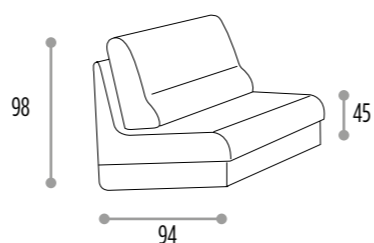

ELEMENTI

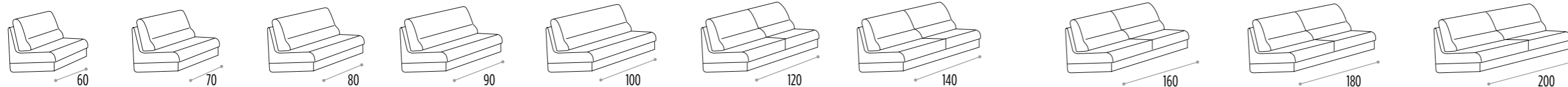

PENISOLA

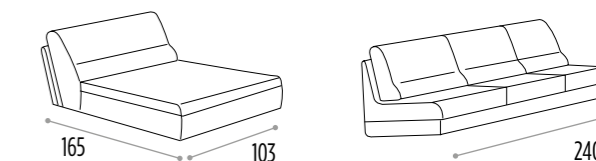

REVERSIBILE

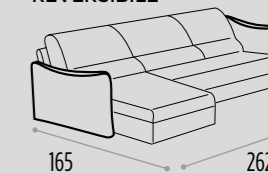

PENISOLA

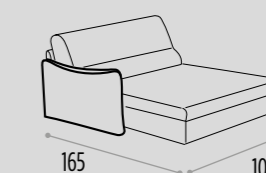

REVERSIBILE

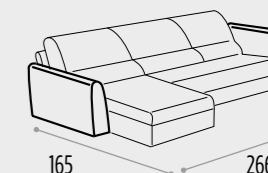

PENISOLA

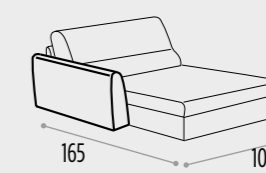

REVERSIBILE

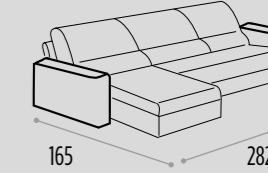

PENISOLA

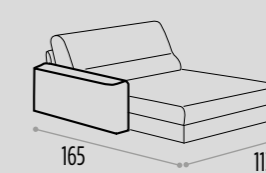

REVERSIBILE

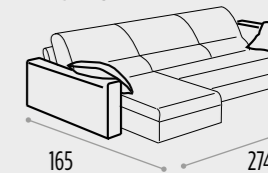

PENISOLA

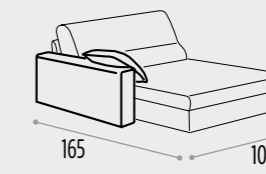

BRACCIOLO PETIT

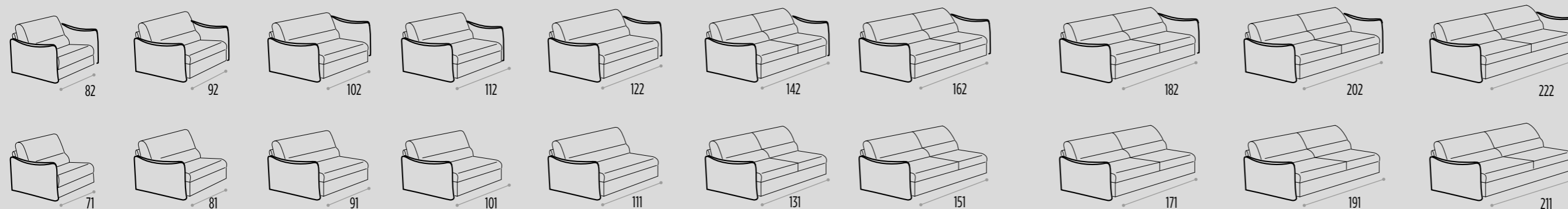

BRACCIOLO PYRAMID

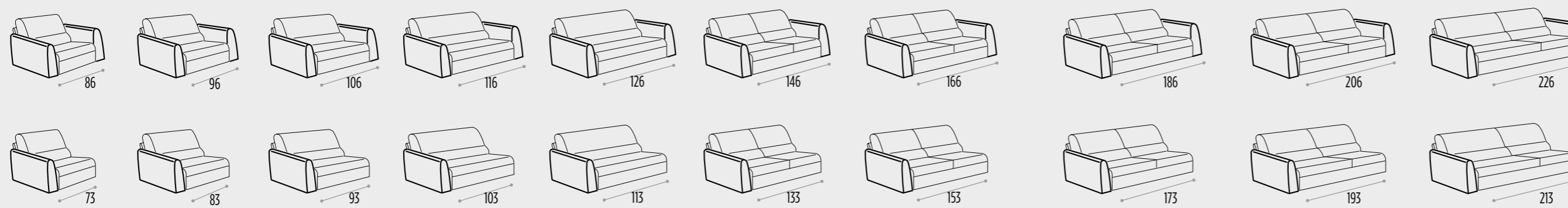

BRACCIOLO OVAL

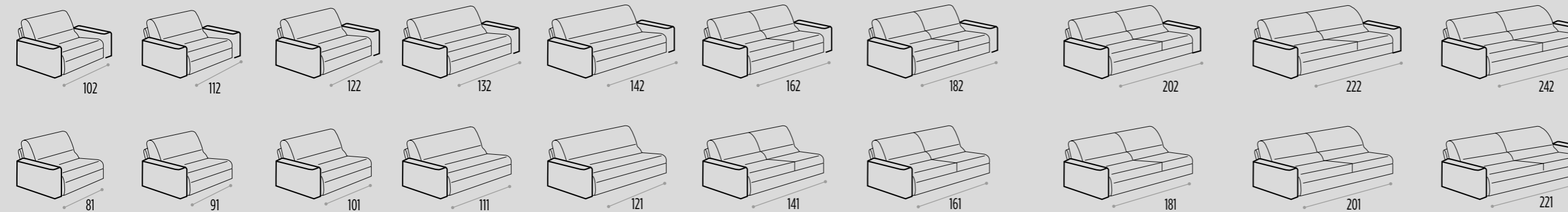

BRACCIOLO SOFT

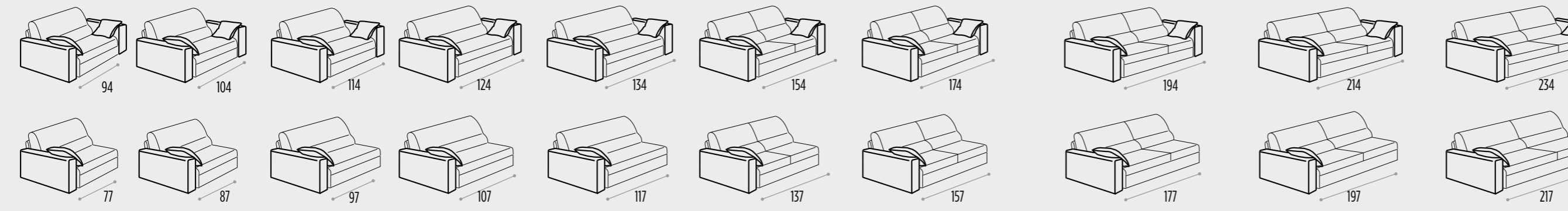

ELEMENTI

TERMINALE CORTO



TERMINALE



ANGOLO

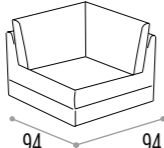

POUFF ZENO QUADRATO

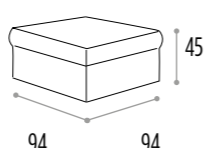

POUFF SI COLLECTION

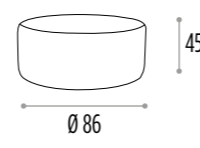

CUSCINO DECOR O6

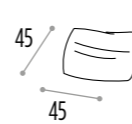

CUSCINO DECOR O8

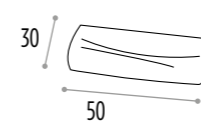

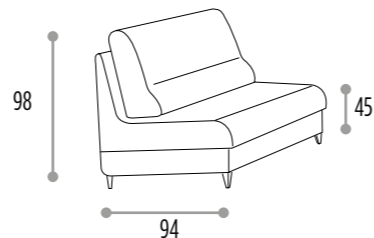

ELEMENTI

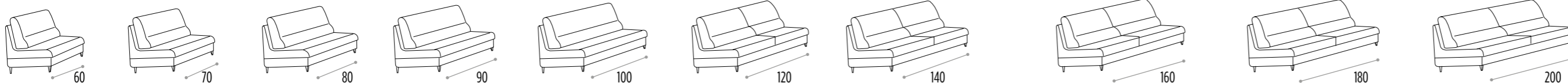

PENISOLA

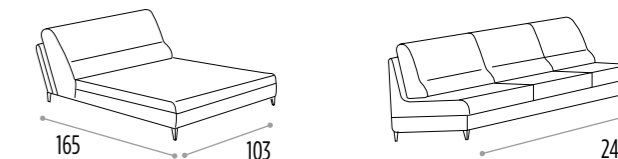

BRACCIOLO PETIT

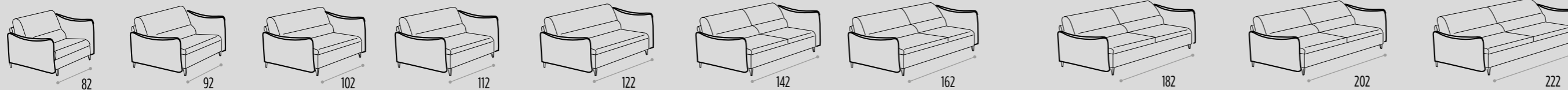

REVERSIBILE

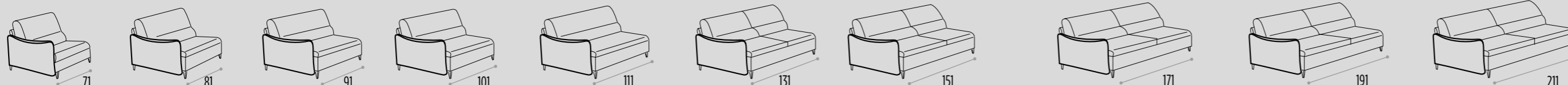
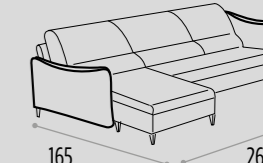

PENISOLA

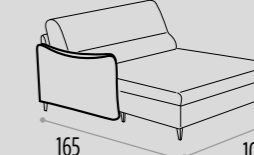

BRACCIOLO PIRAMID



REVERSIBILE

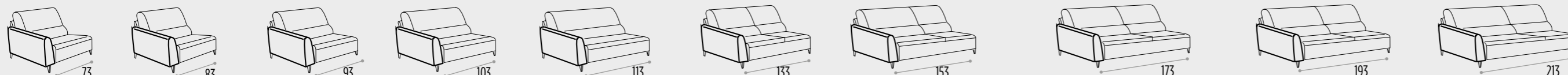
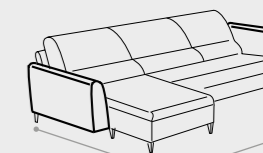

PENISOLA

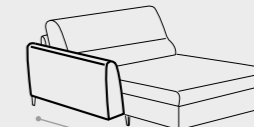

BRACCIOLO OVAL

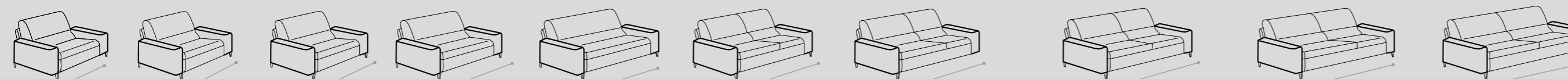

REVERSIBILE

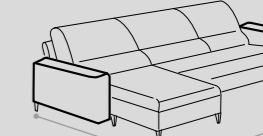

PENISOLA

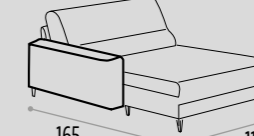

BRACCIOLO SOFT

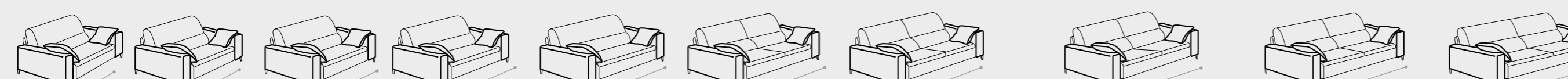

REVERSIBILE

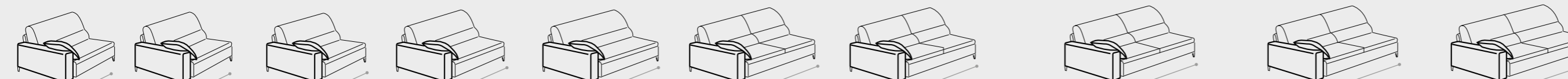
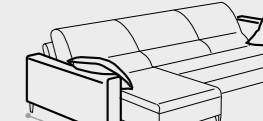

PENISOLA



ELEMENTI

TERMINALE CORTO

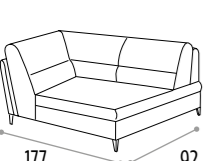

TERMINALE



ANGOLO

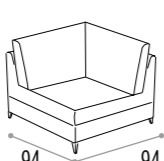

POUFF KENT QUADRATO

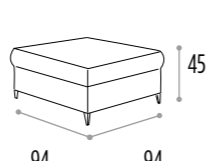

POUFF SI COLLECTION

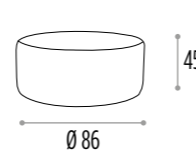

CUSCINO DECOR 06

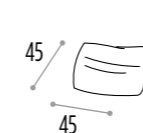

CUSCINO DECOR 08

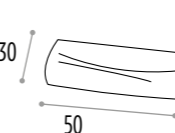

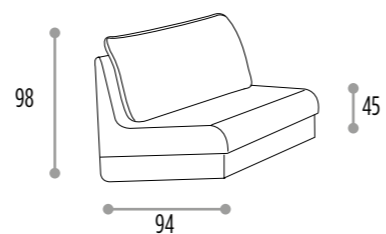

ELEMENTI

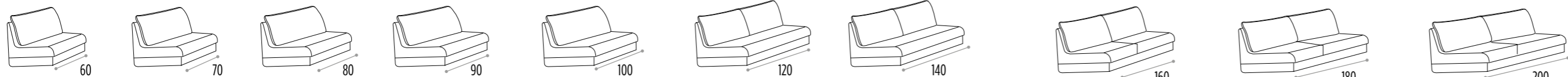

PENISOLA

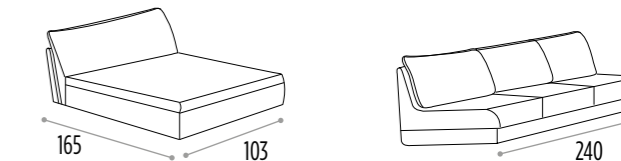

BRACCIOLO PETIT

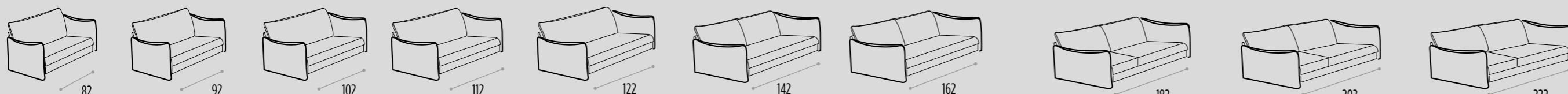

REVERSIBILE

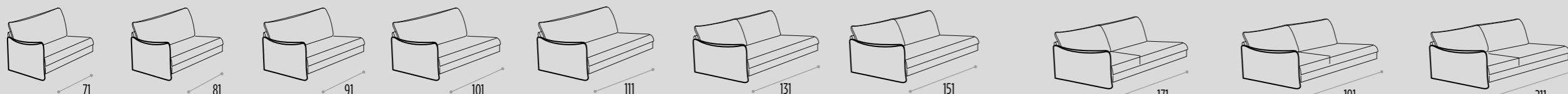
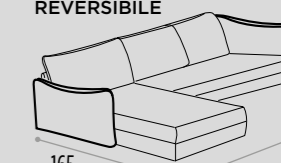

PENISOLA

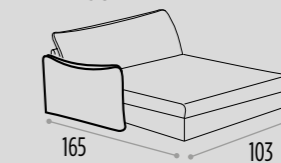

BRACCIOLO PIRAMID

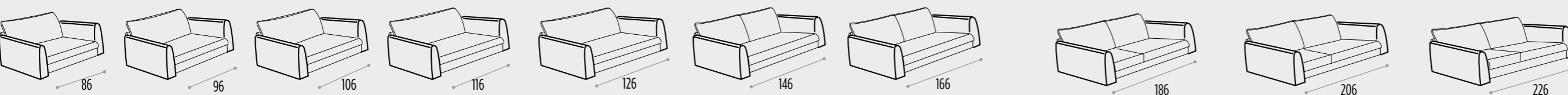

REVERSIBILE

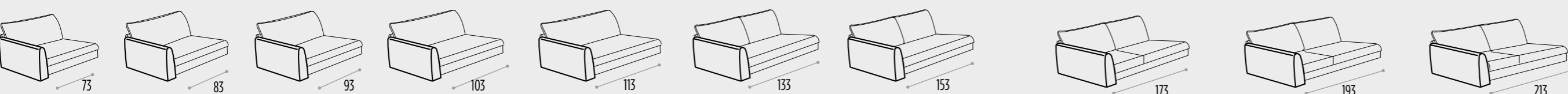
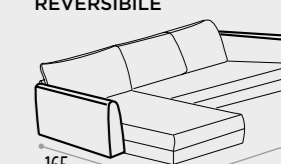

PENISOLA

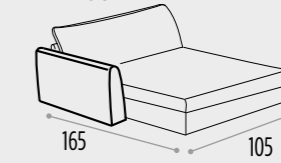

BRACCIOLO OVAL

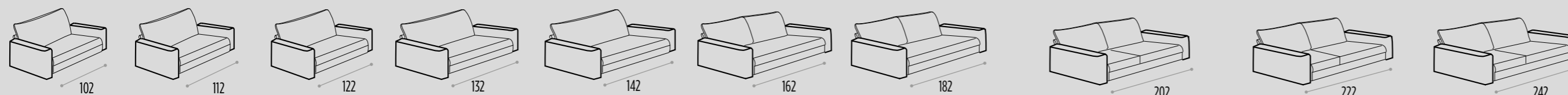

REVERSIBILE

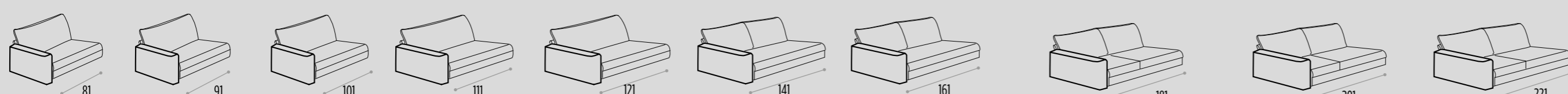
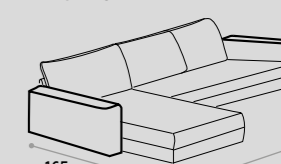

PENISOLA

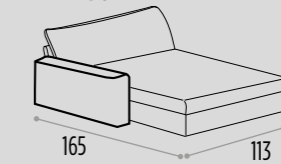

BRACCIOLO SOFT

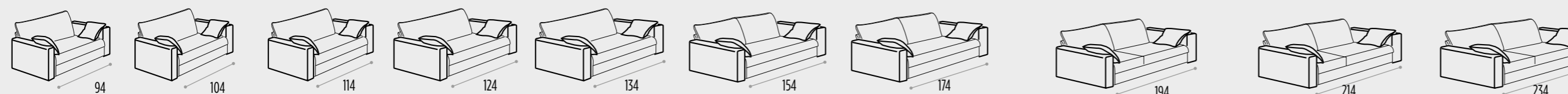

REVERSIBILE

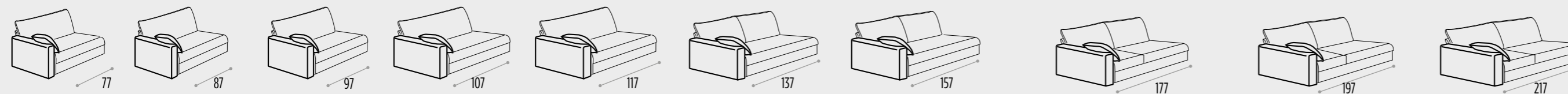
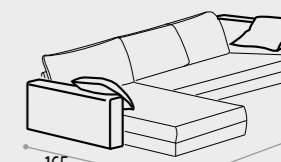

PENISOLA



ELEMENTI

TERMINALE CORTO

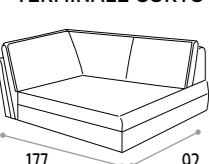

TERMINALE



ANGOLO

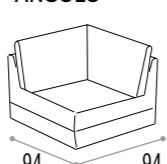

POUFF LINUS QUADRATO

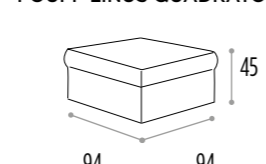

POUFF SI COLLECTION

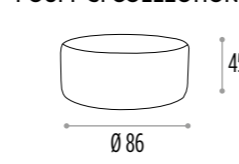

CUSCINO DECOR 06

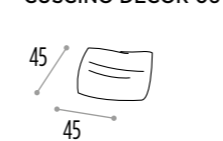

CUSCINO DECOR 08

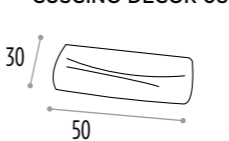

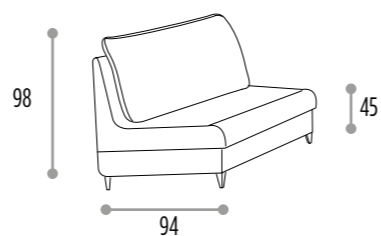

ELEMENTI

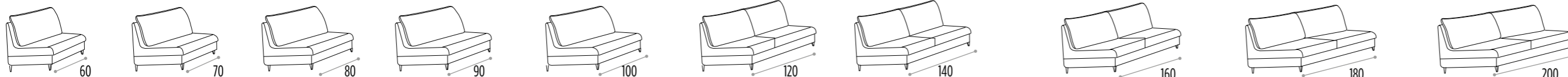

PENISOLA

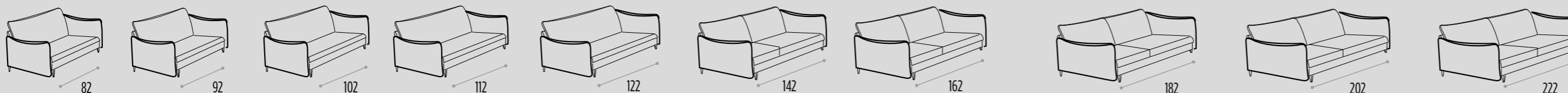
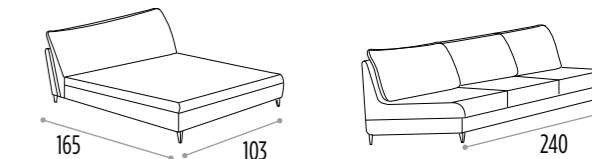

REVERSIBILE

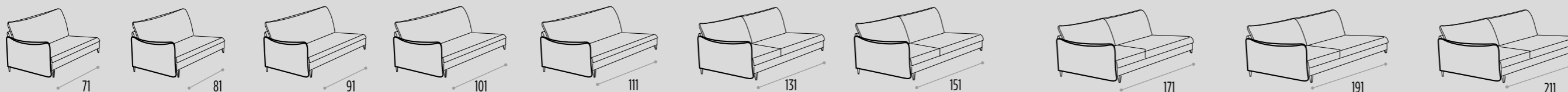
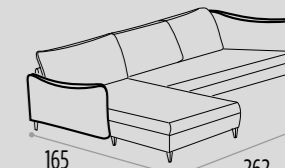

PENISOLA

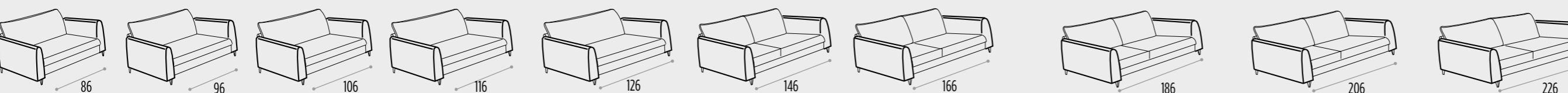
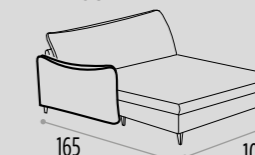

REVERSIBILE

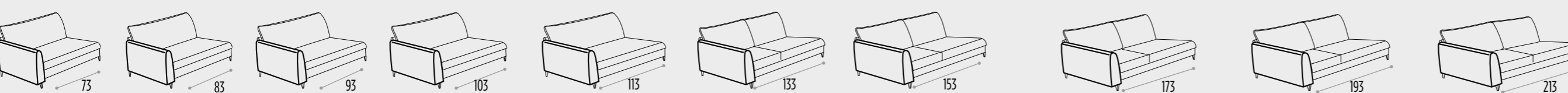
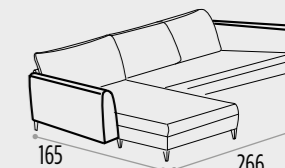

PENISOLA

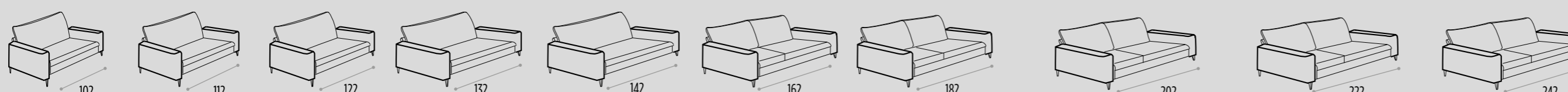
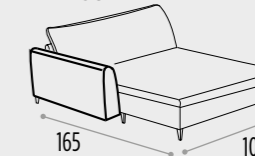

REVERSIBILE

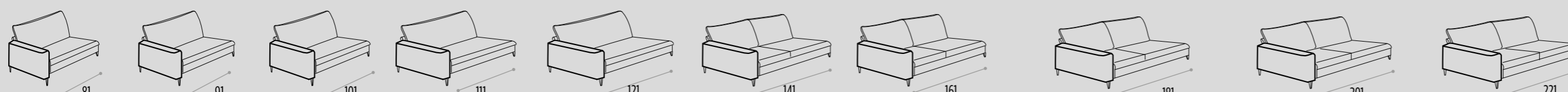
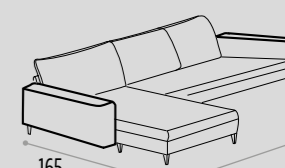

PENISOLA

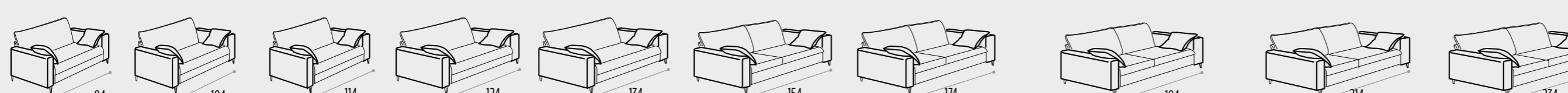
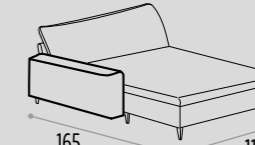

REVERSIBILE

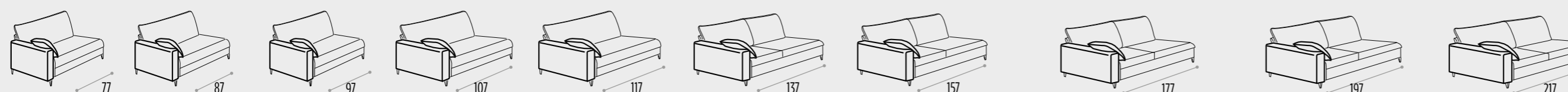
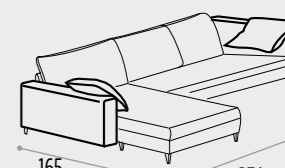

PENISOLA



TERMINALE CORTO

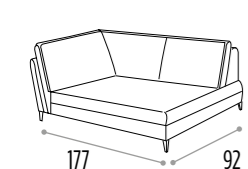

TERMINALE

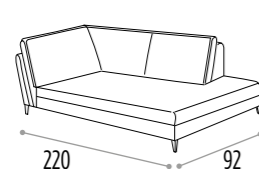

ANGOLO

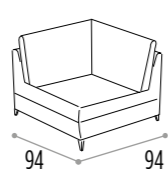

POUFF MARK QUADRATO

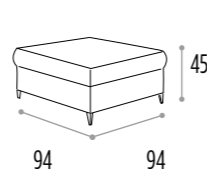

POUFF SI COLLECTION

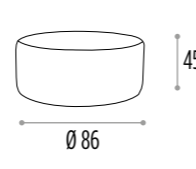

CUSCINO DECOR 06

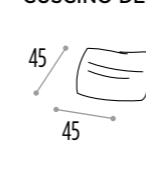

CUSCINO DECOR 08

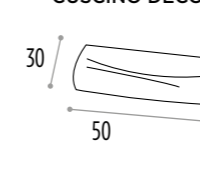

Sì

collection

Design: Liviano Battistoni

Photo: Fotografia

Post Production Images Editing: Fotografia

Graphic Concept / copy: Fotografia

colour Separation: Colorlab TRZ

Print: Leardini grafiche

Printed in Italy

February 2018

Sì
collection

biel
DIVANI ITALIANI
dal 1978

Via Risara, 54
61025 Montelabbate
Pesaro, Italy
tel. 0721 491810 (3 linee r.a.)
fax. 0721 491822
info@biel.it
www.biel.it